

## DEMONSTRATION OF A HIGH SPEED HYBRID ELECTRICAL AND OPTICAL SENSING SYSTEM FOR NEXT GENERATION LAUNCHER APPLICATIONS

Selwan K. Ibrahim<sup>1</sup>, John A. O'Dowd<sup>1</sup>, Arthur Honniball<sup>1</sup>, Vivian Bessler<sup>1</sup>, Martin Farnan<sup>1</sup>,  
Peter O'Connor<sup>2</sup>, Milos Melicher<sup>2</sup>, Danny Gleeson<sup>2</sup>

<sup>1</sup>FAZ Technology Ltd., 9C Beckett Way, Park West Business Park, Dublin 12, Ireland  
selwan.ibrahim@faztechnology.com

<sup>2</sup>Curtiss-Wright, Unit 5, Richview Office Park, Clonskeagh, Dublin 14, Ireland

### ABSTRACT

The Future Launchers Preparatory Programme (FLPP) supported by the European Space Agency (ESA) has a goal of developing various launch vehicle system concepts and identifying the technologies required for the design of Europe's Next-Generation Launcher (NGL) while maintaining competitiveness on the commercial market. Avionics fiber optic sensing technology was investigated as part of the FLPP programme.

Here we demonstrate and evaluate a high speed hybrid electrical/optical data acquisition system based on commercial off the shelf (COTS) technology capable of acquiring data from traditional electrical sensors and optical Fibre Bragg Grating (FBG) sensors. The proposed system consists of the KAM-500 data acquisition system developed by Curtis-Wright and the I4 tunable laser based fiber optic sensor interrogator developed by FAZ Technology. The key objective was to demonstrate the capability of the hybrid system to acquire data from traditional electrical sensors used in launcher applications e.g. strain, temperature and pressure in combination with optical FBG sensors, as well as data delivery to spacecraft avionics systems. The KAM-500 was configured as the main acquisition unit (MAU) and provided a 1 kHz sampling clock to the I4 interrogator that was configured as the secondary acquisition unit (SAU) to synchronize the data acquisition sample rate between both systems. The SAU acquired data from an array of optical FBG sensors, while the MAU data acquisition system acquired data from the electrical sensors.

Data acquired from the optical sensors was processed by the FAZ I4 interrogation system and then encapsulated into UDP/IP packets and transferred to the KAM-500. The KAM-500 encapsulated the optical sensor data together with the data acquired from electrical sensors and transmitted the data over MIL-STD-1553 and Ethernet data interface. The temperature measurements resulted in the optical and electrical sensors performing on a par with each other, with all sensors recording an accuracy within 0.35% FS over the full temperature range of -70°C to +180°C. The pressure measurements were performed over a 0 to 5 bar absolute pressure range and over different temperatures across a -40°C to +80°C range. The tests concluded that the optical pressure sensors performed on par with the electrical pressure sensor for each temperature set, where both sensor technologies measured a pressure accuracy of 1.2% FS. As for the strain measurements, the results show the optical and electrical sensors can measure to within 1% FS (Full Scale) of measurement range  $\pm 1,200 \mu\text{strain}$ .

The proposed hybrid system can be potentially used for next generation launcher applications delivering weight reduction, improvement in measurement coverage and reduction in Assembly, Integration and Testing (AIT) over traditional electrical systems.

### I. INTRODUCTION

To improve the reliability and reduce the cost of launcher systems, multiple sensors are installed and used for such systems. The current Ariane 5 uses over 500 wired electrical sensors for functional and telemetry purposes which requires a lot of effort in installation and testing in addition to the extra weight generated by the electrical cable harnesses solutions [1-5]. Wireless solutions have been proposed, however techniques to deliver power to the sensors and electromagnetic interference (EMI) is still a challenge [2]. Optical fibre sensing solutions overcome the requirement to deliver power and is immune to EMI [3-5].

Fig. 1 shows the different sections and stages of the Ariane 5 where in each section a different number of electrical sensors (e.g. surface/ambient temperature, strain, pressure, vibration) with different measurement specifications and ranges are required [6].

This paper shows a Telemetry Subsystem (TMSS) Demonstrator that was developed under the ESA Future Launcher Proprietary Programme 2.2 (FLPP2.2) were a list of electrical sensors that are currently deployed on the ESC-A and ESP stages of the ARIANE5 were selected and tested with their counterpart optical sensors.

The purpose of the system was to demonstrate that fibre optic sensing may be incorporated, and considered for next generation launchers for weight reduction, improving measurement coverage and reducing Assembly, Integration and Testing over traditional electrical systems.

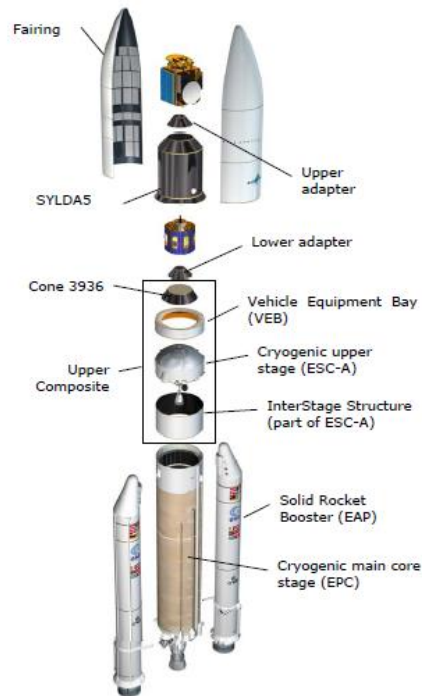

Fig. 1. Diagram of Ariane 5 Sections [6]

I. TMSS DEMONSTRATOR

The TMSS Demonstrator consists of the Curtis Wright CWC-AE COTS KAM-500 equipment which is considered as the Main Acquisition Unit (MAU) and the FAZ Technology COTS I4 fibre optic sensing platform [7] is considered as the Secondary Acquisition Unit (SAU) as shown in Fig. 2.

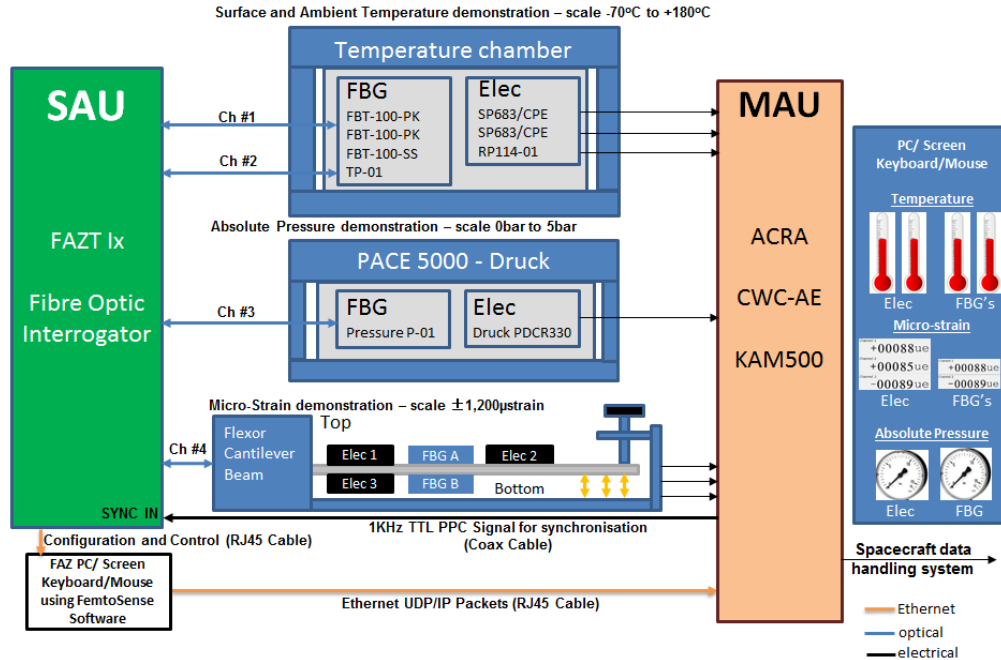

Fig. 2. TMSS Demonstrator Overview

The SAU acquires data from an array of optical Fibre Bragg Grating (FBG) sensors, while the MAU data acquisition system acquires data from traditional electrical sensors. The SAU FAZ I4 interrogator has 4 optical channels allowing multiplexing of up to 30 FBG sensors per fibre and supporting up to 120 FBG sensors connected to 1 SAU unit all sampled simultaneously at 1 kHz. The MAU handles the data received by the SAU and relays the data to the spacecraft avionics system. The MAU manages the acquisition of the measurements from the secondary units via an Ethernet connection, and also provides power to the electrical sensors. The SAU unit is

powered independently to the MAU. The SAU acquires the data from the optical FBG sensors and sends the raw wavelength data to the FAZ PC. The FAZ PC processes the wavelengths into actual sensor readings i.e. temperature, strain, and pressure. The FAZ PC then formats the data into UDP/IP packets and send the packets to the MAU over an Ethernet connection. Synchronisation between the MAU and the SAU is achieved by using a hardware generated sync signal (gate/clock). The MAU provides the SAU with a PPC (Pulse per Cycle) signal of 1 kHz, where the SAU synchronises the start of the sweep of the tunable laser, and also begins acquisition on the rising edge of the signal received from the PPC single from the MAU. Different types of measurements (temperature, pressure, strain) were carried out according to table 1 below showing the range, type of each measurement.

**Table 1.** TMSS Demonstrator Measurement Matrix

Demonstrator (Sensor Type)	Electrical Sensors			Optical Sensor (FBG)		Measurement Parameters		
	Electrical Sensor	Supplier	Sensor Technology	Fibre Optic sensor	Supplier	Testing Range	Sample rate	No. of Sensors
Surface Temperature	SP683/CPE	Atexis	PT100 RTD 3 wire	FBT-100-PK STS-01	Lakeshore Sylex	-70°C to 180°C	1kHz	2 Elec 2 Optical
Ambient Temperature	RP114-01	Auxitrol	PT100 RTD 3 wire	FBT-100-PK FBT-100-SS	Lakeshore Lakeshore	-70°C to 180°C	1kHz	1 Elec 2 Optical
Absolute Pressure	PDCR330- 2633-05	DRUCK	Strain Gage, Thin Film	Pressure Sensor - P01	Sylex	5 bar	1kHz	1 Elec 1 Optical
Micro-strain	CEA-13- 125UN-350 CEA-13- 062UT-350	Vishay	Strain Gage, Thin Film	Strain Gauge - SG01	FBGS	±1,200 µstrain	1kHz	3 Elec 2 Optical

### III. TEMPERATURE TEST

The temperature test involved testing both ambient and surface temperature sensors. A total of seven sensors were tested, of which there were two electrical surface temperature sensors (SP683/CPE), and two optical surface temperature sensors (STS-01 and FBT-100-PK), which were all mounted to an aerospace graded aluminium plate (aluminium grade 2024 T4). The other three sensors were used for ambient temperature of which there were one electrical ambient sensor (RP114-01), and two optical ambient temperature sensors (FBT-100-PK and FBT-100-SS). The optical sensors (FBT-100-PK) were configured in series on the one fibre channel (one for ambient and one for surface). There were two other single ended optical sensors; one custom made Surface Temperature Sensor (STS-01) from Sylex, and one single ended optical ambient sensor from Lakeshore (FBT-100-SS). A comparison of ambient and surface sensing technologies was carried out for both optical and electrical sensors.

The test involved continuous acquisition during the temperature cycle from -70°C to +180°C and then back down to -70°C. The chamber was controlled through Labview. It was programmed that when the internal thermostat in the temperature chamber settled to within 0.2°C of the desired set temperature, and then the chamber dwelled for a period of 20 minutes. This was repeated in 10°C increments over the entire temperature cycle -70°C to +180°C and then back down to -70°C. The MAU continuously recorded over the full cycle at 1 kHz sample rate and low pass filtered the data over a 15 Hz signal bandwidth. The graph in Fig. 3 plots all the measurement points over the entire test, where the oven was cycled from -70°C to 180°C and back to -70°C, with 10°C steps.

The tests resulted in the optical and electrical sensors performing on par with each other, with all seven sensors recording an accuracy of <0.35%FS over the full temperature cycle -70°C to +180°C. The specifications of the optical and electrical sensors have a stated measurement accuracy of 0.2°C. However, it was observed that the temperature chamber struggled to maintain the set temperature (temperature of oven deviated by 0.5°C) as evident in the Fig. 4 showing a zoomed in plot of all the measurement points over a period of 40 minutes to demonstrate the response of the sensors at a set temperature -70°C. It seems that both optical and electrical pick up the response of the temperature chamber as it continuously attempts to maintain the temperature set point, where the temperature chamber fluctuates at each temperature set point by ~0.2-0.5°C.

This concludes the accuracy of measurement of the optical and electrical sensors was dependent on the fluctuation of temperature chamber control loop at each temperature set point.

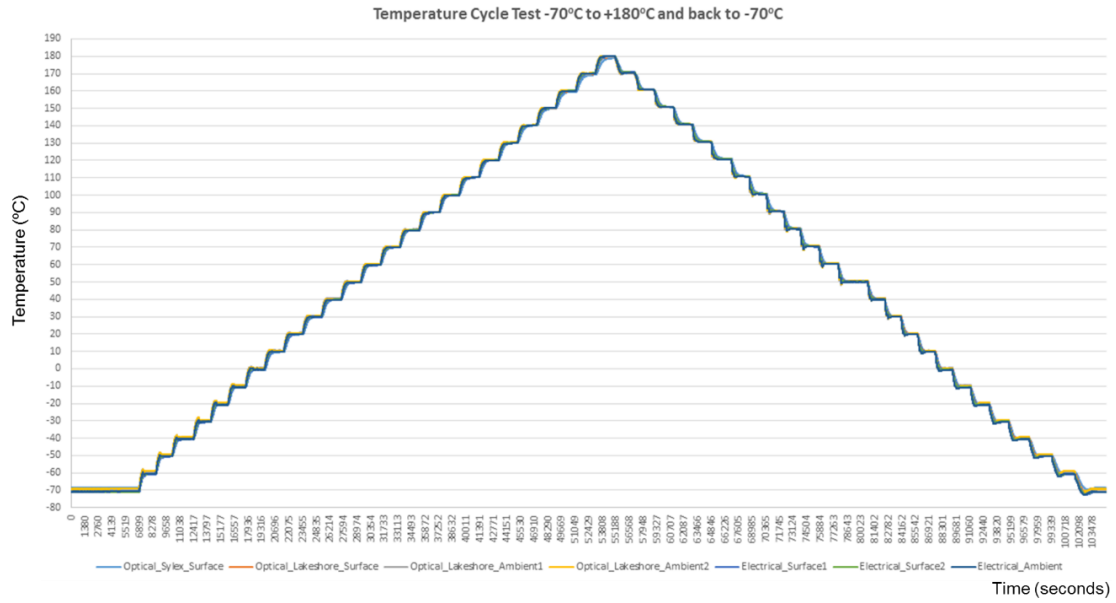

Fig. 3. Overall test graph of Surface and Ambient temperature sensors

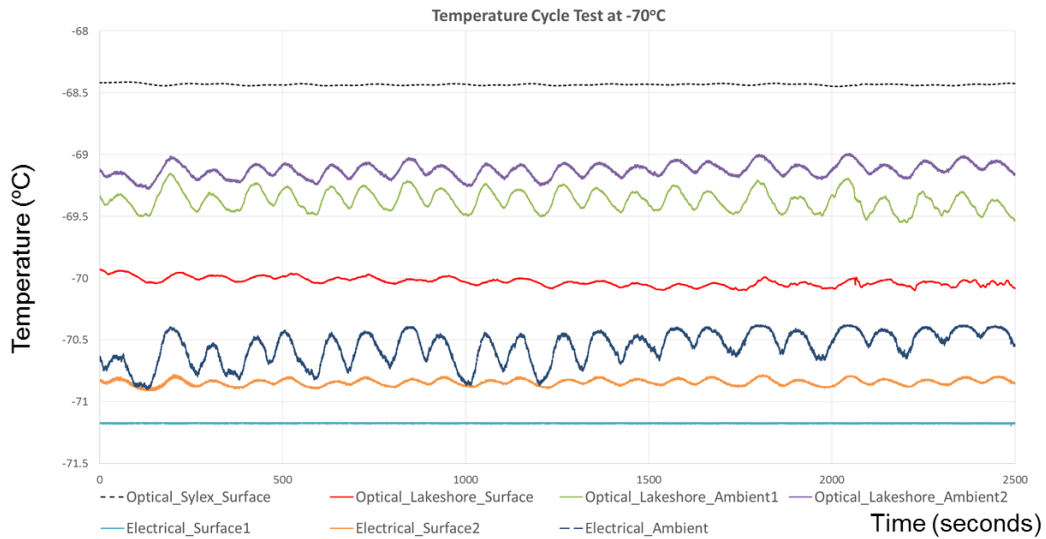

Fig. 4. Temperature Cycle Test zoomed in at -70°C

The plot in Fig. 5 shows the difference in temperature sensor readings compared to that of the stable oven thermocouple measurement (within 0.2°C for >20 minutes).

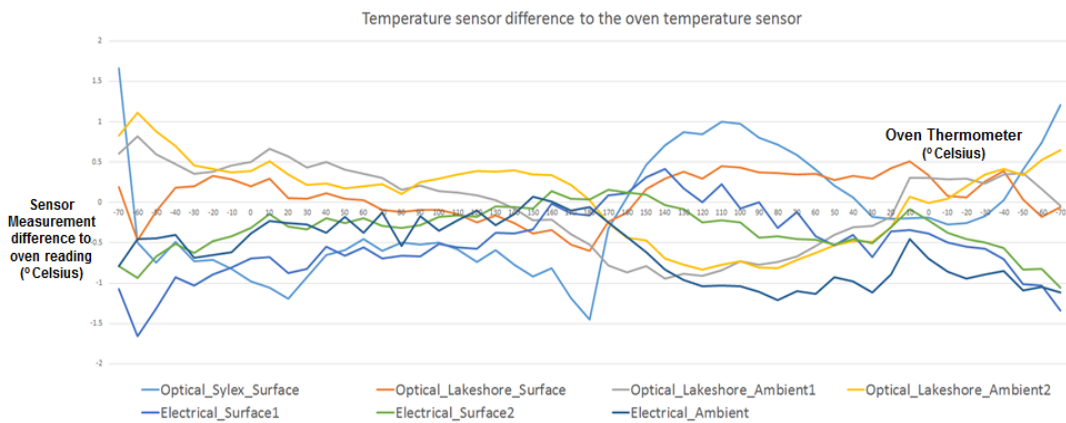

Fig. 5. Temperature sensor readings difference to oven thermocouple

Within this experiment the optical sensors (FBT-100-PK) were configured in series on the one fibre channel (one for ambient and one for surface). There was also a single ended optical ambient sensor from Lakeshore (FBT-100-SS). All three sensors proved to produce the correct temperature readings over the full temperature cycle, thus concluding that there is no difference seen in measurement accuracy if the optical sensors are connected in series or as a single ended optical sensor. Also, within this experiment polynomial equations were used as opposed to sensor Look up Tables (LUT) to convert the wavelengths of the sensors to actual temperature values.

The Ambient Temperature Lakeshore FBT-100-SS and FBT-100-PK can be fit with two 2nd or 3rd order polynomials depending the level of accuracy required and the temperature range required. For example to cover the entire temperature range, a 5th order polynomial equation can be used to give a  $\pm 0.1^\circ\text{C}$  accuracy over the full temperature range  $-70^\circ\text{C}$  to  $+180^\circ\text{C}$ . However, if the required level of accuracy is reduced to  $\pm 1^\circ\text{C}$  over the temperature range than a 3rd order polynomial may be used. The Lakeshore optical sensors (FBT-100-PK) proved that the manufacturer's calibration polynomial equation derived from the LUT stays within calibration after installation, thus ruling out the need for re-calibration after assembly and installation. The sensors also proved that there is no effect on the temperature measurements with induced strain. Therefore after all the temperature sensor tests, one may conclude that the Lakeshore optical sensors (FBT-100-PK) may be considered for the next generation launcher programme. The Lakeshore sensors form factor and weight is similar to that of the traditional electrical sensors.

#### IV. PRESSURE TEST

The pressure test was set up to simultaneously measure the pressure of both the optical pressure sensor (P-01), and the electrical pressure sensor (Druck - PDCR330-2633-05) which is currently in use on the Ariane5 launchers. The absolute pressure range for this test is from 0 bar to 5 bar over the temperature range of  $-40^\circ\text{C}$  to  $+80^\circ\text{C}$ . A pressure controller (PACE 5000) was used to control the pressure output to the stainless steel tubing connected to both the optical sensor and electrical pressure sensor via a T-Bar connector. A CM2-B module is inserted into the back of the PACE 5000. A nitrogen tank (Technical grade N2, x10S) supplies the pressure to the PACE5000. A regulator is required between the Nitrogen tank and the PACE5000; to regulate the pressure from 200bar (Nitrogen tank pressure) down to the barometric pressure required as an input to the PACE5000. A vacuum pump (P4Z) is required to get from 1bar pressure down to 0 bar pressure. The PACE5000 internally controls the required output pressure through software (Labview). The output pressure is fed from the PACE5000 to a T-bar connector which has equal pressure at each end piece. The optical pressure sensor (P-01) is connected to one end of the T-bar and an electrical Druck - PDCR330-2633-05 sensor on the other end. Both the electrical pressure sensor (Druck - PDCR330-2633-05), and optical pressure sensor (P-01) were placed in the temperature chamber. The pressure controller was stepped through the pressure ranges 0 bar to 5 bar and back to 0 bar at each of the temperature set points;  $-40^\circ\text{C}$ ,  $0^\circ\text{C}$ ,  $+40^\circ\text{C}$ , and  $+80^\circ\text{C}$ . The temperature chamber was set to dwell at the desired set point for 20 minutes once it was within  $0.2^\circ\text{C}$  of the set point. The data was recorded by the KAM500 at sample rate of 1 kHz.

A plot of all the pressure cycles from 0 bar to 5 bar and back to 0 bar at all the temperature set points  $-40^\circ\text{C}$ ,  $0^\circ\text{C}$ ,  $+40^\circ\text{C}$ , and  $+80^\circ\text{C}$  are shown in Fig. 6 below. At each set point the pressure cycle took 3.5 minutes (210 seconds) to complete. The plot shows an overlay of all the pressure measurements at the four temperature set points.

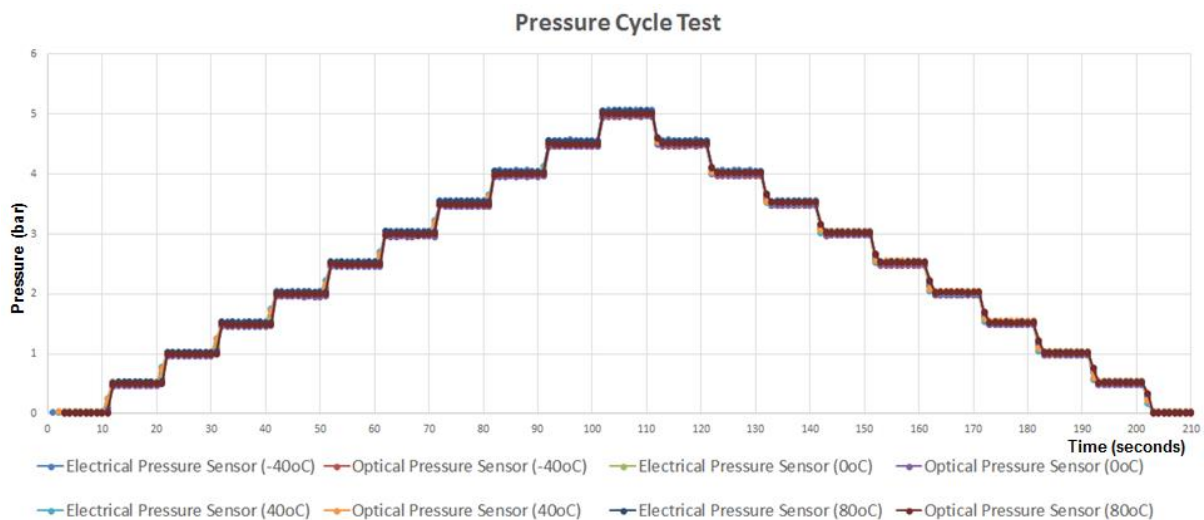

Fig. 6. Pressure test results plot

Fig. 7 is a plot of the difference in pressure measurements to that of the high precision Druck5000 Pressure Controller for both optical and electrical sensors for each temperature set point. The tests concluded that the optical pressure sensors performed on par with the electrical pressure sensor for each temperature set point (-40°C, 0°C, 40°C and +80°C), where both sensor technologies measured a pressure accuracy of 1.2% FS (Full Scale).

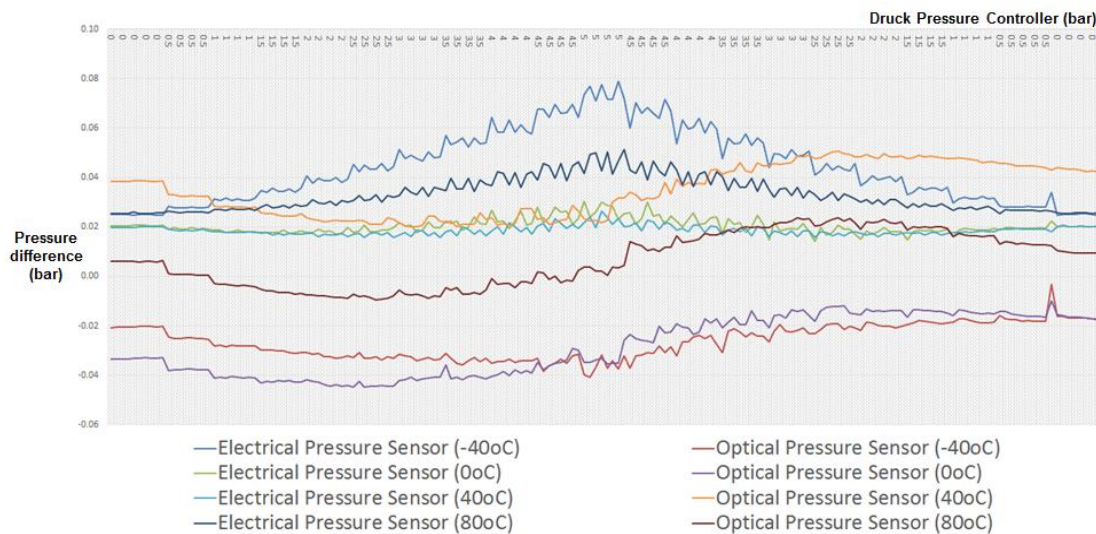

Fig. 7. Difference in pressure measurements to the Druck5000 Pressure Controller

Fig. 8 is a zoomed in version of the pressure cycle increasing from 1.5 bar to 2 bar and to 2.5 bar. The measurements in the plot below were taken when the oven was settled at -40°C. The data was down sampled from 1 kHz to 10Hz.

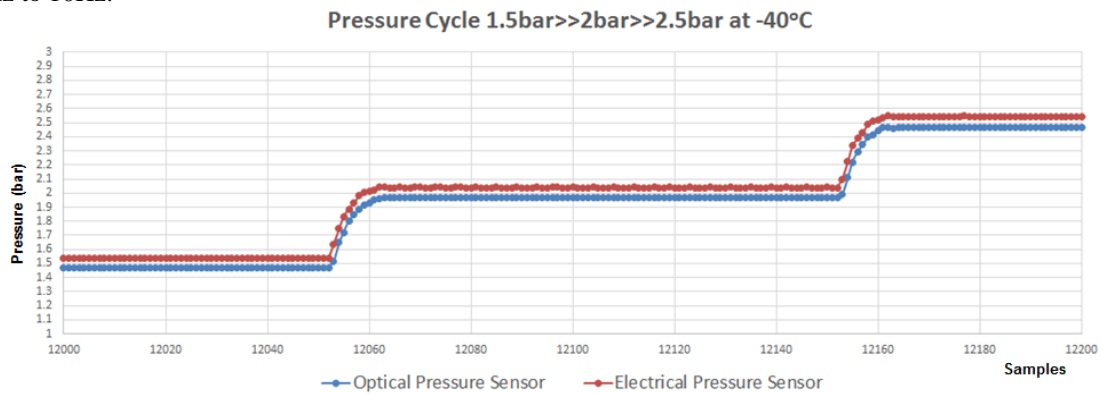
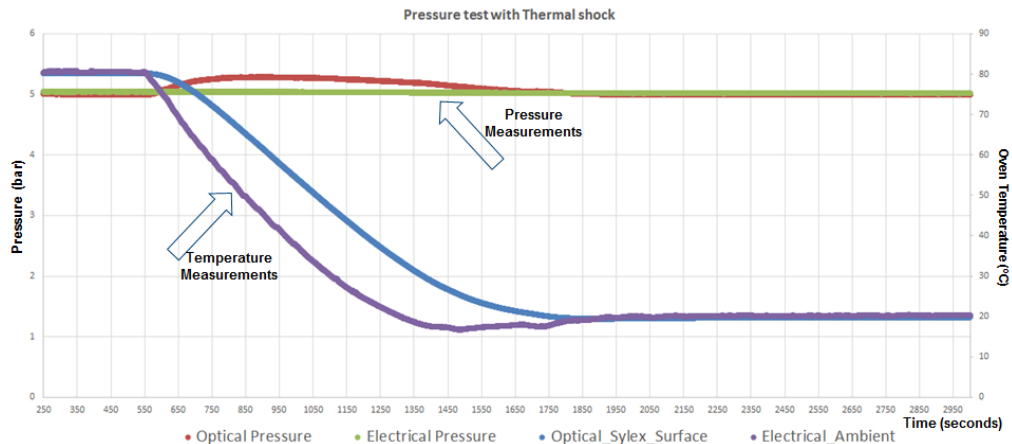

Fig. 8. Pressure test results plot increasing from 1.5bar>>2bar>>2.5bar @ -40°C

A temperature shock test was also carried out on the electrical and optical sensors by placing them in the temperature chamber and connecting them to the Druck pressure controller where the pressure was set to a constant 5 bar. The temperature chamber was set to 80°C and allowed to settle for 20 minutes. Once the chamber temperature and the pressure sensors settled, the temperature chamber was set to 20°C (rate of oven temperature change ~3°C/minute). Fig. 9 below is a plot of the electrical (green) and optical (red) pressure measurements at 5 bar. The Optical Sylex Surface temperature sensor (blue) and electrical temperature sensor (purple) sensor are also recorded for this test and plotted on the graph.



**Fig. 9.** Pressure Test with temperature shock plot

The optical pressure sensor has an internal temperature compensation sensor within the pressure sensor package. As shown in the graph, the temperature compensation sensor struggles to compensate correctly while temperature shock is applied. The pressure measurement of the optical pressure sensor measuring 5 bar at beginning of the experiment, when temperature shock is applied the optical pressure measurement drifts to 5.3 bar or 0.3 bar (6%FS) deviation, while the electrical pressure sensor stays within 0.01 bar throughout the experiment. The change in temperature from 80°C down to 20°C takes around 20 minutes. It should be noted that the response of both the ambient temperature (purple) and the surface temperature measurements (blue) shows difference between the two temperature sensors mainly due to the mass and thermal conductivity of the sensors. It can be considered that the pressure measurement drift during temperature shock may be due to the internal temperature compensation sensor inside the optical pressure sensor has a different thermal conductivity to that of the internal optical pressure sensor. Thus, a conclusion from this test would be to design an optical pressure sensor that has the same internal thermal conductivity for both internal optical sensors (temperature and pressure). Also an alternative design of an absolute pressure sensor using a differential FBG measurement technique was demonstrated recently and potentially can be used to replace the P-01 [8, 9]

## V. MICRO-STRAIN TEST

The micro-strain test was set up to demonstrate the use of fibre optic FBG sensors to measure micro-strain of a structure using micro-strain optical sensors (SG-01) and optical temperature sensors for temperature compensation (TC-Probe), and to compare to electrical micro-strain sensors (CEA-13-250UW-350), which are currently in use on the Ariane5 launcher. The electrical and optical sensors were glued to an aerospace graded aluminium flexor cantilever beam (aluminium grade 2024 T4), based on the manufacturer's recommendations for mounting both electrical strain foil gauges, and optical sensors. The micro-strain range for this demonstration was cycled from 0  $\mu$ strain to 1,200  $\mu$ strain and back to 0  $\mu$ strain.

The optical sensor (FBG) on the top of the beam was placed in between the two electrical gages (Elec Gauge 1 and Elec Gauge 2) on the top of the beam. An average of these two gauges are taken which should equal the optical gauge (Optical Top). The test shows similar measurements for both the electrical and optical sensors. For negative micro-strain (on the bottom side of the beam) the optical and electrical sensors were mounted beside one another. The overall test showed minor differences in the two technologies. An optical temperature compensation probe was used to measure the change in temperature during the experiment where the temperature results were off-set from the micro-strain measurements before the packets were sent to the KAM500 module. The optical temperature compensation is necessary as a change in temperature by 1°C, equates to a 10 $\mu$ strain error of measurement, therefore the need for a temperature compensation probe is required for accurate  $\mu$ strain measurements.

Fig. 10 shows a plot of the test results for the micro-strain test at room temperature (0  $\mu$ strain to 1,200  $\mu$ strain and back to 0  $\mu$ strain) showing both the optical and electrical sensors measure to within 1% FS (Full Scale) of measurement range  $\pm$ 1,200  $\mu$ strain.

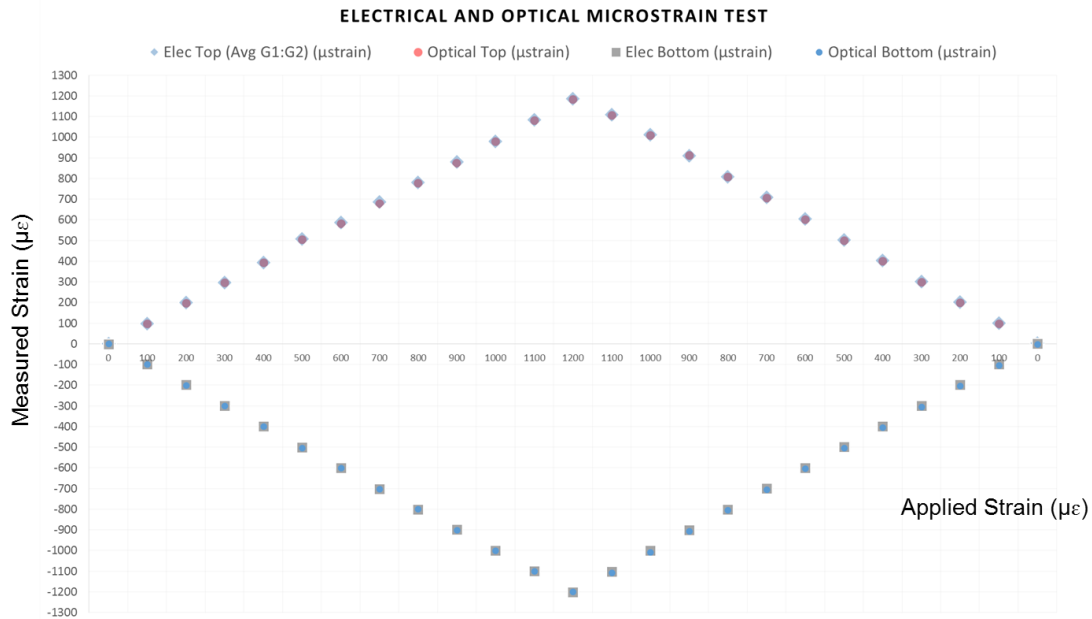

Fig. 10. Micro-strain test results plot

## VI. CONCLUSION

The TMSS demonstrator concluded that both optical sensors and the SAU I4 optical sensing platform combined with the electrical sensors and MAU KAM-500 electrical sensing platform are at a mature technology stage, easily configurable COTS product that provides low latency, deterministic data with simultaneous 1kHz sampling rate and accuracy of 0.35% F.S. for temperature and 1.2% F.S for micro-strain and pressure measurements. The proposed hybrid system can be potentially used for next generation launcher applications delivering weight reduction, improvement in measurement coverage and reduction in Assembly, Integration and Testing (AIT).

## VII. ACKNOWLEDGEMENT

This work was supported by the European Space Agency (ESA) Future Launcher Proprietary Programme 2.2 (FLPP2.2) under contract no. N-4200022863/10/F/IZ, WO-3.

## REFERENCES

- [1] M. Trojaola, "Sensors and systems in space: Ariane 5," *Sensors and Actuators A: Physical*, 37, pp. 233-238, 1993.
- [2] H. Beestermöller, J. Sebald, M. Sinnreich, H. Borchers, M. Schneider, H. Luttmann, "Wireless-Sensor Networks in Space Technology Demonstration on ISS," *12. Dresdner Sensor-Symposium*, pp. 99-102, 2015.
- [3] I. McKenzie, and N. Karafolas, "Fiber optic sensing in space structures: the experience of the European Space Agency," *17th International Conference on Optical Fibre Sensors*, Proc. SPIE 5855, 262-269, 2005.
- [4] S. Abad, F. Araujo, F. Pinto, J. González Torres, R. Rodriguez, M.A. Moreno, "Fiber Optic Sensing Subsystem for Temperature Monitoring in Space In-flight Applications," *ICSO 2014, Session 4D Fiber Optic Sensors and Active Optical Cables*, 2014
- [5] S.K. Ibrahim, J. O'Dowd, R. McCue, A. Honniball, and M. Farnan, "Design Challenges of a High Speed Tunable Laser Interrogator for Future Spacecraft Health Monitoring," *CLEO 2015: Applications and Technology*, ATu1M-3, 2015.
- [6] Ariane 5\_users\_manual\_Issue5, July 2011 (<http://www.arianespace.com/vehicle/ariane-5/>)
- [7] S.K. Ibrahim, M. Farnan, D.M. Karabacak, J.M. Singer, "Enabling technologies for fiber optic sensing," *SPIE Photonics Europe 2016*, Proc. SPIE 9899, Optical Sensing and Detection IV, 98990Z, 2016.
- [8] D. M. Karabacak, M. Farnan, S. K. Ibrahim, M. Todd, J. M. Singer, "Fiber Optic Sensors for Multiparameter Monitoring Of Large Scale Assets," *8th European Workshop on Structural Health Monitoring Series EWSHM 2016*, 373, 2016.
- [9] D. M. Karabacak, S. K. Ibrahim, Y. Koumans, M. Farnan, R. Knoppers, J. M. Singer, "High-speed system for FBG-based measurements of vibrations and sound," *SPIE Commercial + Scientific Sensing and Imaging 2016*, Fiber Optic Sensors and Applications XIII, 9852-16, 2016.